











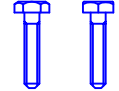

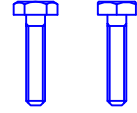

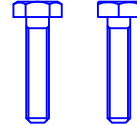

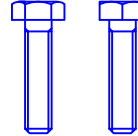

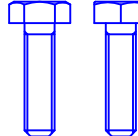

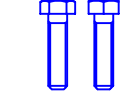

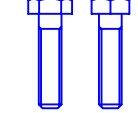

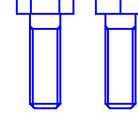

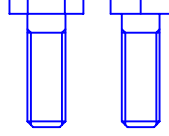

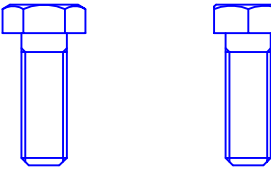

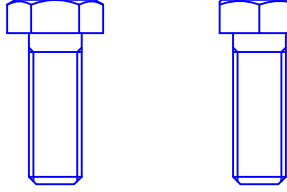

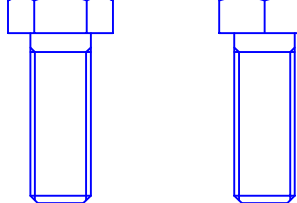
※各ボルトの長さは任意に変更してご使用ください。

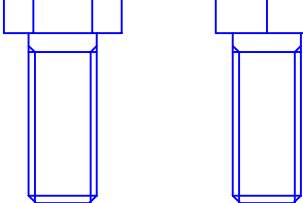
M1.6   (S=1/1)	M2.0   (S=1/1)	M2.5   (S=1/1)	M3   (S=1/1)	<M3.5>   (S=1/1)	M4   (S=1/1)	M5   (S=1/1)	M6   (S=1/1)	M8   (S=1/1)	M10   (S=1/1)
M12  	<M14>  	M16  	<M18>  	M20  	<M22>  	M24  			
<M27>  	M30  	<M33>  	M36  	<M39>  					

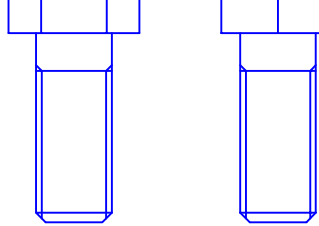
※各ボルトの長さは任意に変更してご使用ください。

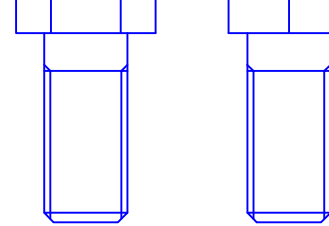
M42

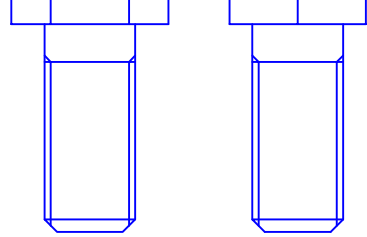
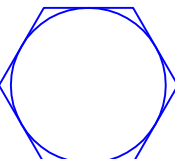
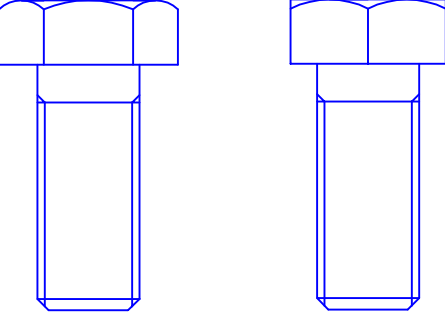
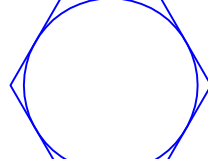
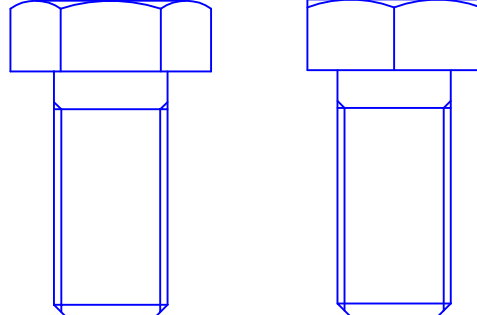
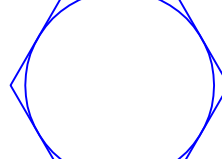
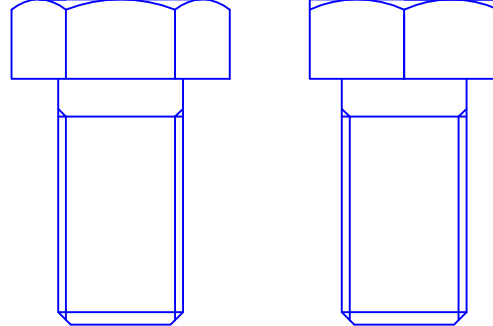
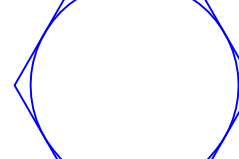
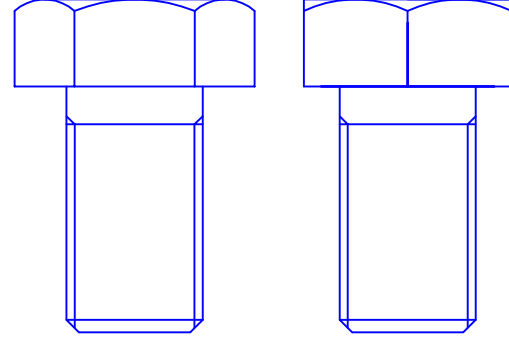
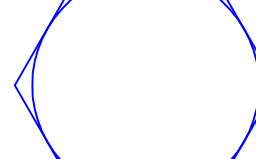
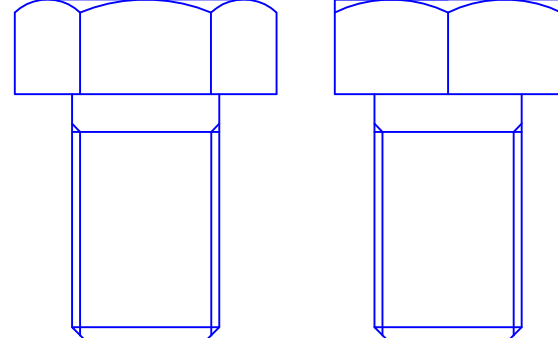
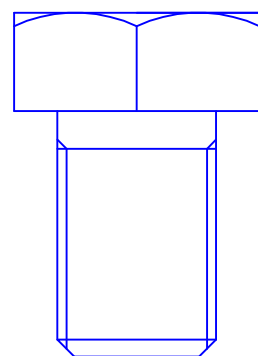
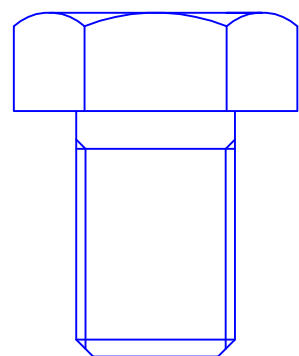
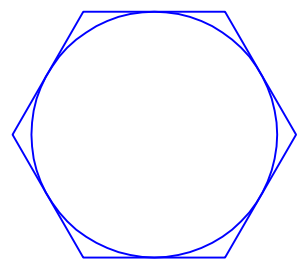

〈 M45 〉

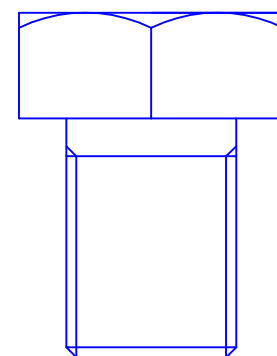
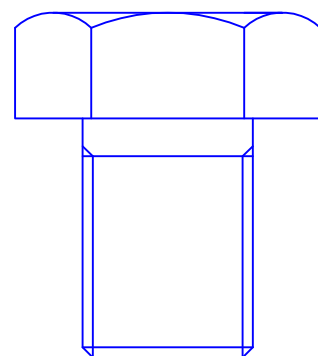
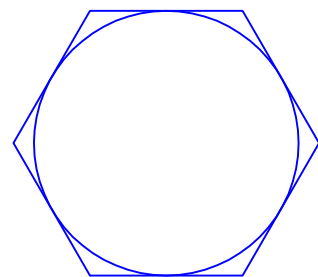

M48

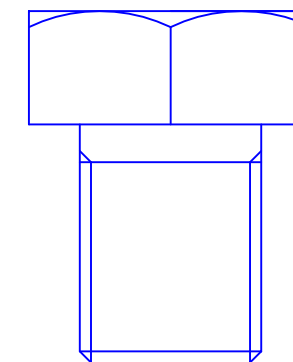
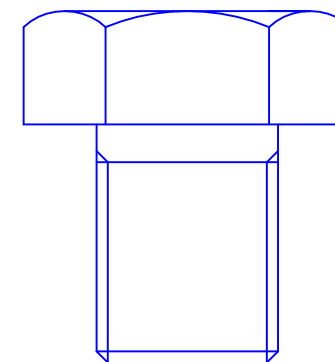
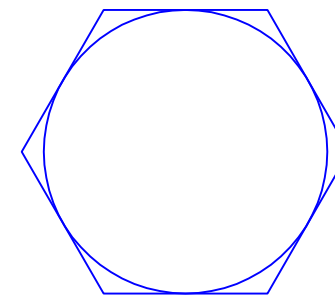

〈 M52 〉

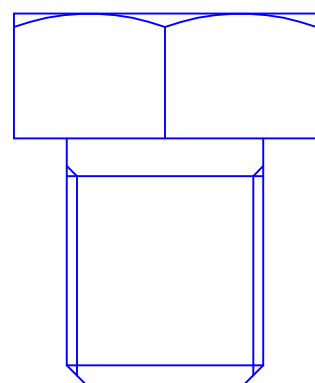
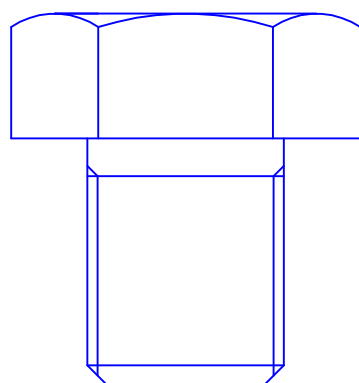
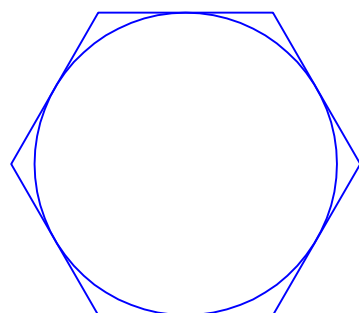

M56

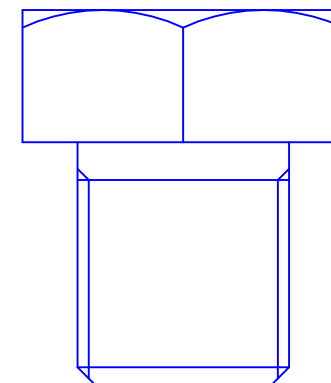
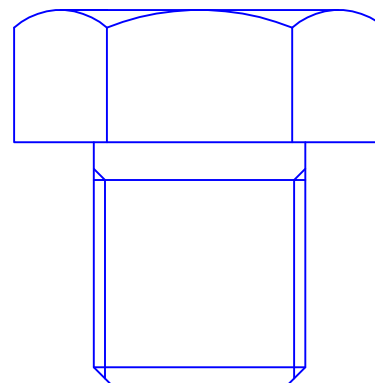
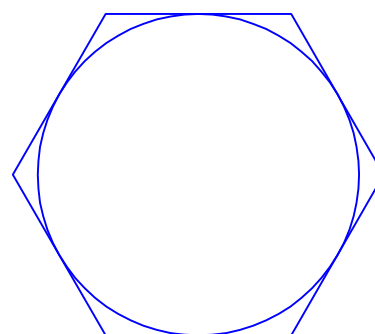

〈 M60 〉

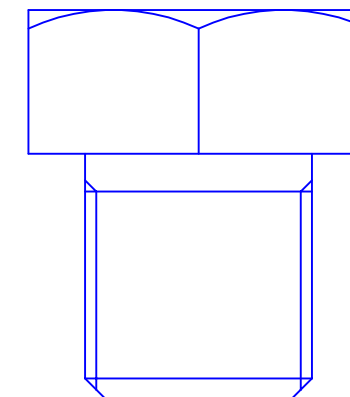
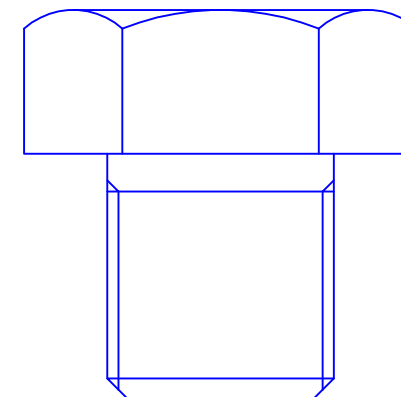
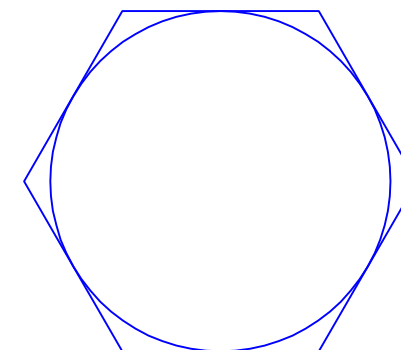

M64

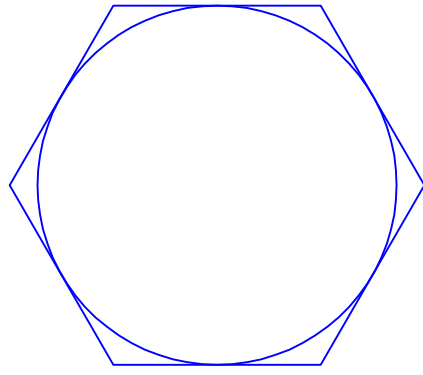

※ボルトの長さは  
任意に変更して  
ご使用ください。

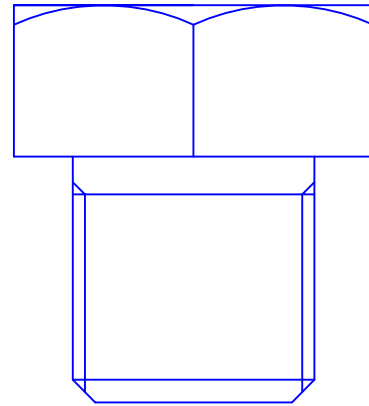
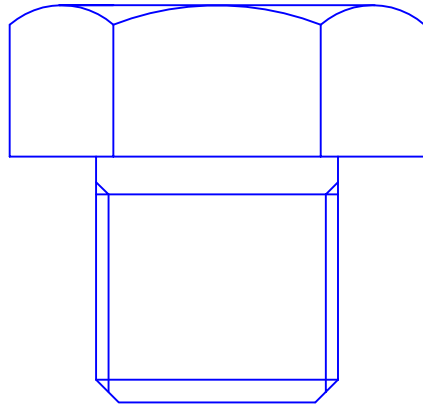

【お知らせ】六角ボルト・六角ナットのJIS改正について

2014年 4月 21日付けで、六角ボルト（JIS B 1180）・六角ナット（JIS B 1181）の規格が改正されました。

附属書の技術的内容をそのまま存続することとしたものの、  
「新しい設計では使わないことが望ましい」と、明記されております。

一般社団法人日本ねじ工業協会、日本ねじ商業協同組合連合会では、広くその内容を周知するためのガイドとして  
「六角ボルト・ナット 附属書品から本体規格品への切り替えガイド」を作成されましたので、お知らせいたします。

なお、ねじ業界は2020年までに、本体規格品の供給体制を整えんとされています。

※詳細は下記 PDF、URLをご覧ください。

- ・ 「六角ボルト・ナット 附属書品から本体規格品への切り替えガイド」  
<http://www.fij.or.jp/pdf/JISGuide.pdf>
- ・ 一般社団法人日本ねじ工業協会  
<http://www.fij.or.jp/>